



1719 Ex I/O

Catalog numbers 1719-AENTR, 1719-IJ, 1719-IBN8B, 1719-IF4HB, 1719-IR4B, 1719-IT4B, 1719-OB2, 1719-OB2L, 1719-CF4H, 1719-PSDC, 1719-A22, 1719-A8, 1719-A24, 1719-TB6, 1719-TB6S, 1719-TB8, 1719-TB8S, 1719-TB8Sx2, 1719-TB8x2, 1719-CBL, 1719-ARM

Table of Contents

Topic	Page
Important User Information	2
Enclosure	3
Prevent Electrostatic Discharge	3
North American Hazardous Location Approval	4
European Hazardous Location Approval	5
IEC Hazardous Location Approval	6
Adapter Considerations	8
Installing the Backplane	9
Connections	10
Inserting and Removing Modules	15
Field Wiring	16
Coding	18
Line Fault Detection	19
Cold Junctions in Thermocouples	20
Wire Resistance in Resistance Thermometers	20
EtherNet/IP Connection	21
Potential Equalization and Shielding	22
Additional Resources	26

Important User Information

Solid-state equipment has operational characteristics differing from those of electromechanical equipment. Safety Guidelines for the Application, Installation and Maintenance of Solid State Controls (Publication [SGI-1.1](#) available from your local Rockwell Automation sales office or online at <http://www.rockwellautomation.com/literature/>) describes some important differences between solid-state equipment and hard-wired electromechanical devices. Because of this difference, and also because of the wide variety of uses for solid-state equipment, all persons responsible for applying this equipment must satisfy themselves that each intended application of this equipment is acceptable.





In no event will Rockwell Automation, Inc. be responsible or liable for indirect or consequential damages resulting from the use or application of this equipment.

The examples and diagrams in this manual are included solely for illustrative purposes. Because of the many variables and requirements associated with any particular installation, Rockwell Automation, Inc. cannot assume responsibility or liability for actual use based on the examples and diagrams.

No patent liability is assumed by Rockwell Automation, Inc. with respect to use of information, circuits, equipment, or software described in this manual.

Reproduction of the contents of this manual, in whole or in part, without written permission of Rockwell Automation, Inc., is prohibited.

Throughout this manual, when necessary, we use notes to make you aware of safety considerations.

	WARNING: Identifies information about practices or circumstances that can cause an explosion in a hazardous environment, which may lead to personal injury or death, property damage, or economic loss.
	ATTENTION: Identifies information about practices or circumstances that can lead to personal injury or death, property damage, or economic loss. Attentions help you identify a hazard, avoid a hazard and recognize the consequences.
	SHOCK HAZARD: Labels may be on or inside the equipment (for example, drive or motor) to alert people that dangerous voltage may be present.
	BURN HAZARD: Labels may be on or inside the equipment (for example, drive or motor) to alert people that surfaces may reach dangerous temperatures.
IMPORTANT	Identifies information that is critical for successful application and understanding of the product.

Enclosure

The 1719 Ex I/O distributed I/O is specially designed for operation within an enclosure or within a monitored environment. Observe the requirements for enclosures and the installation conditions set out in the chapter on safety of the 1719 Ex I/O User Manual, publication number [1719-UM001](#).



WARNING: Risk of explosion.

Electrostatic charging of plastic components can lead to discharge, which can cause explosive mixtures to ignite.

- Avoid electrostatic charges. For example, plastic parts must always be cleaned using a damp cloth, and never using a dry cloth.
 - Affix a warning sign that is easily recognizable to the inside of the enclosure. The sign must read as follows: "WARNING — avoid electrostatic charge".
-

Prevent Electrostatic Discharge





ATTENTION: This equipment is sensitive to electrostatic discharge, which can cause internal damage and affect normal operation. Follow these guidelines when you handle this equipment.

- Touch a grounded object to discharge potential static.
 - Wear an approved grounding wriststrap.
 - Do not touch connectors or pins on component boards.
 - Do not touch circuit components inside the equipment.
 - Use a static-safe workstation, if available.
 - Store the equipment in appropriate static-safe packaging when not in use.
-



At the end of its life, this equipment should be collected separately from any unsorted municipal waste.

North American Hazardous Location Approval

The following information applies when operating this equipment in hazardous locations:	Informations sur l'utilisation de cet équipement en environnements dangereux:
<p>Products marked "CL I, DIV 2, GP A, B, C, D" are suitable for use in Class I Division 2 Groups A, B, C, D, Hazardous Locations and nonhazardous locations only. Each product is supplied with markings on the rating nameplate indicating the hazardous location temperature code. When combining products within a system, the most adverse temperature code (lowest "T" number) may be used to help determine the overall temperature code of the system. Combinations of equipment in your system are subject to investigation by the local Authority Having Jurisdiction at the time of installation.</p>	<p>Les produits marqués "CL I, DIV 2, GP A, B, C, D" ne conviennent qu'à une utilisation en environnements de Classe I Division 2 Groupes A, B, C, D dangereux et non dangereux. Chaque produit est livré avec des marquages sur sa plaque d'identification qui indiquent le code de température pour les environnements dangereux. Lorsque plusieurs produits sont combinés dans un système, le code de température le plus défavorable (code de température le plus faible) peut être utilisé pour déterminer le code de température global du système. Les combinaisons d'équipements dans le système sont sujettes à inspection par les autorités locales qualifiées au moment de l'installation.</p>
<div style="display: flex; align-items: center;">  <div> <p>EXPLOSION HAZARD</p> <ul style="list-style-type: none"> • Do not disconnect equipment unless power has been removed or the area is known to be nonhazardous. • Do not disconnect connections to this equipment unless power has been removed or the area is known to be nonhazardous. Secure any external connections that mate to this equipment by using screws, sliding latches, threaded connectors, or other means provided with this product. • Substitution of components may impair suitability for Class I, Division 2. • If this product contains batteries, they must only be changed in an area known to be nonhazardous. </div> </div>	<div style="display: flex; align-items: center;">  <div> <p>RISQUE D'EXPLOSION</p> <ul style="list-style-type: none"> • Couper le courant ou s'assurer que l'environnement est classé non dangereux avant de débrancher l'équipement. • Couper le courant ou s'assurer que l'environnement est classé non dangereux avant de débrancher les connecteurs. Fixer tous les connecteurs externes reliés à cet équipement à l'aide de vis, loquets coulissants, connecteurs filetés ou autres moyens fournis avec ce produit. • La substitution de composants peut rendre cet équipement inadapté à une utilisation en environnement de Classe I, Division 2. • S'assurer que l'environnement est classé non dangereux avant de changer les piles. </div> </div>

European Hazardous Location Approval

The following applies to products marked   II 3 G: Such modules:

- Are Equipment Group II, Equipment Category 3, and comply with the Essential Health and Safety Requirements relating to the design and construction of such equipment given in Annex II to Directive 2014/34/EU. See the EC Declaration of Conformity at <http://www.rockwellautomation.com/products/certification> for details.
- Are intended for use in areas in which explosive atmospheres caused by gases, vapors, mists, or air are unlikely to occur, or are likely to occur only infrequently and for short periods. Such locations correspond to Zone 2 classification according to ATEX directive 1999/92/EC.
- The I/O modules are associated apparatus with outputs leading into Category 1 [Zone 0 (gas) or Zone 20 (dust)].

1719-CF4H

- Field connections and mounting: the type of protection is "Ex nA [ia Ga] IIC T4 Gc" and "[Ex ia Da] IIIC", comply to Standards EN 60079-0:2009, EN 60079-11:2007, EN 60079-15:2010, and EN 60079-26:2007. Certificate BVS 11 ATEX E 116 X.

1719-IF4HB

- Field connections and mounting: The type of protection is "Ex nA [ia Ga] IIC T4 Gc" and "[Ex ia Da] IIIC", comply to Standards EN 60079-0:2009, EN 60079-11:2012, EN 60079-15:2010, and EN 60079-26:2007. Certificate BVS 12 ATEX E 024 X.

1719-IR4B, 1719-IT4B, 1719-IBN8B, 1719-IJ

- Field connections: the type of protection is "[Ex ia] IIC" and "[Ex ia] IIIC", comply to Standards EN 60079-0:2009 and EN 60079-11:2007. Certificate PTB 03 ATEX 2042.
- Mounting: the type of protection is "Ex nA IIC T4 Gc", comply to Standards EN 60079-0:2009 and EN 60079-15:2010. Certificate PF 08 CERT 1234 X.

1719-OB2, 1719-OB2L

- Field connections and mounting: The type of protection is "Ex nA [ia Ga] IIC T4 Gc", and "[Ex ia Da] IIIC", comply to Standards EN 60079-0:2012+A11:2013, EN 60079-11:2012, and EN 60079-15:2010. Certificate EXA 16 ATEX 0025X.

1719-AENTR

- Mounting: the type of protection is "Ex nA IIC T4 Gc", comply to Standards EN 60079-0:2012+A11:2013 and EN 60079-15:2010. Certificate DEMKO 16 ATEX 1780X.

1719-PSDC

- Mounting: the type of protection is "Ex nA IIC T4 Gc", comply to Standards EN 60079-0:2009 and EN 60079-15:2010. Certificate PF 08 CERT 1234 X.

IEC Hazardous Location Approval

The following applies to products with IECEx certification: Such modules:

- Are intended for use in areas in which explosive atmospheres caused by gases, vapors, mists, or air are unlikely to occur, or are likely to occur only infrequently and for short periods. Such locations correspond to Zone 2 classification to IEC 60079-0.

1719-CF4H

- Field connections and mounting: the type of protection is "Ex nA [ia Ga] IIC T4 Gc" and "[Ex ia Da] IIIC", comply to Standards IEC 60079-0:2011, IEC 60079-11:2011-06, IEC 60079-15:2010, and IEC 60079-26:2006. Certificate IECEx BVS 11.0068X.

1719-IF4HB

- Field connections and mounting: The type of protection is "Ex nA [ia Ga] IIC T4 Gc" and "[Ex ia Da] IIIC", comply to Standards IEC 60079-0:2011, IEC 60079-11:2011, IEC 60079-15:2010, and IEC 60079-26:2006. Certificate IECEx BVS 12.0055X.

1719-IR4B, 1719-IT4B, 1719-IBN8B, 1719-IJ

- Field connections and mounting: The type of protection is "Ex nA [ia Ga] IIC T4 Gc", and "[Ex ia Da] IIIC", comply to Standards IEC 60079-0:2007-10, IEC 60079-11:2006, IEC60079-15:2005-03, and IEC 60079-26:2006. Certificate IECEx BVS 09.0037X.

1719-OB2, 1719-OB2L

- Field connections and mounting: The type of protection is "Ex nA [ia Ga] IIC T4 Gc", and "[Ex ia Da] IIIC", comply to Standards IEC 60079-0:2011, IEC 60079-11:2011 and IEC 60079-15:2010. Certificate IECEx EXA 16.0010X.

1719-AENTR

- Mounting: the type of protection is " Ex nA IIC T4 Gc ", comply to Standards IEC 60079-0:2011 and IEC 60079-15:2010. Certificate IECEx UL 16.0141X.

1719-PSDC

- Mounting: the type of protection is "Ex nA IIC T4 Gc" comply to Standards IEC 60079-0:2007-10 and IEC60079-15:2005-03. Certificate IECEx BVS 09.0037X.



ATTENTION: This equipment is not resistant to sunlight or other sources of UV radiation.



WARNING: This equipment shall be mounted in an ATEX/IECEx Zone 2 certified enclosure with a minimum ingress protection rating of at least IP54 (as defined in EN/IEC 60529) and used in an environment of not more than Pollution Degree 2 (as defined in EN/IEC 60664-1) when applied in Zone 2 environments. The enclosure must be accessible only by the use of a tool.

WARNING: Provision shall be made to prevent the rated voltage from being exceeded by transient disturbances of more than 140% of the rated voltage when applied in Zone 2 environments.

WARNING: Secure any external connections that mate to this equipment by using screws, sliding latches, threaded connectors, or other means provided with this product.

WARNING: Do not disconnect equipment unless power has been removed or the area is known to be nonhazardous.

Adapter Components

Refer to the following figure to identify the components of the 1719-AENTR adapter.

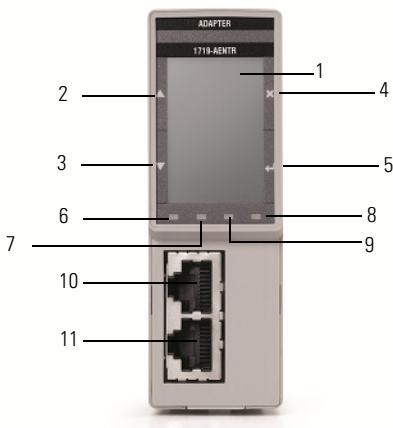

	Description		Description
1	LCD screen	7	NET LED (Network Status)
2	Up navigation	8	LINK1 LED (Link Status Port 1)
3	Down navigation	9	LINK2 LED (Link Status Port 2)
4	Cancel/Back	10	Ethernet Port 1
5	Enter/OK	11	Ethernet Port 2
6	OK LED (Adapter Status)		

Adapter Considerations

To effectively use your 1719-AENTR adapter, note the following considerations.



ATTENTION: To prevent damage to the 1719-AENTR adapter, connect all Ethernet cables before the adapter is powered on and avoid disconnecting Ethernet cables while the adapter is online.

Determine Compatibility

The 1719-AENTR Add-on Profile must be used with one of the following:

- RSLogix 5000, version 24 or later
- RSLinx, version 3.74 or later

Add-on Profile Considerations

- The adapter can be configured using the Add-on Profile. For more information, refer to the Add-on Profile help.
- In the Add-on Profile display, on the Module Info page, the Internal State of the adapter shows Run mode regardless of the status of the controller (Program mode or Run mode).
- Modules can only be reset by inhibiting the module through the Add-on Profile.

Installing the Backplane



ATTENTION: This product is grounded through the DIN rail to chassis ground. Use zinc-plated yellow-chromate steel DIN rail to assure proper grounding. The use of other DIN rail materials (for example, aluminum or plastic) that can corrode, oxidize, or are poor conductors, can result in improper or intermittent grounding. Secure DIN rail to mounting surface approximately every 200 mm (7.8 in.) and use end-anchors appropriately.

1. Install the backplane horizontally on the DIN rail (Allen-Bradley part number 199-DR1; 46277-3; EN50022).
2. If you install the backplane vertically, arrange the power supplies at the top to achieve a favorable heat distribution. Make sure that the maximum ambient temperature for the components is not exceeded.
For more information, refer to Appendix B - Technical Data of the 1719 Ex I/O User Manual, publication number [1719-UM001](#).

Connections

A backup fuse is required for 24V power cables. We recommend using one fuse per 24V power cable. The used fuses have to be rated with 4 AT. This means 4 A slow blow.



ATTENTION: Damage to equipment

Equipment can be damaged by voltages that are too high, for example, in temporary faulty operation.

Ensure that the supply voltage of the power supplies used in Zone 2 does not exceed 33.6V DC (24V x 1.4).

1719-A8 Connections

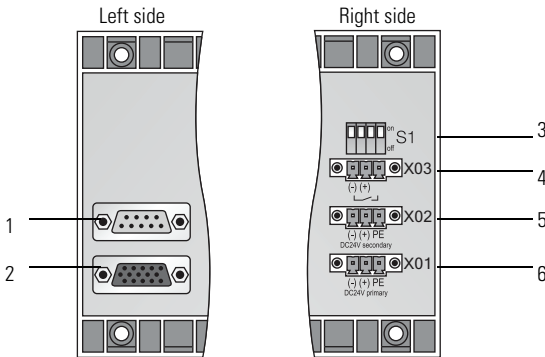

	Description		Description
1	X6: Service interface. Currently not used.	3	S1: Function switch
2	X7: Extension connection for 1719-A24 extension chassis. Note: Online addition of an extension backplane while the system is in Run mode is not supported.	4	X03: Bus-independent deactivation of the I/O modules.
		5	X02: 24V DC redundant power supply
		6	X01: 24V DC power supply

S1 Switch Positions and X03 Terminal Assignment (1719-A8)

The S1 switch and X03 terminal control the bus-independent deactivation of the I/O modules.

The bus-independent deactivation of the I/O modules only works for I/O modules equipped with a shutdown input (1719-OB2, 1719-OB2L). I/O modules with and without a shutdown input can be installed on the same backplane; however, only the I/O modules that are equipped with a shutdown input are controlled by the bus-independent deactivation.

If I/O modules equipped with a shutdown input are installed on the backplane, these modules can be deactivated using an external switch, for example.



ATTENTION: Damage to equipment

Do not handle connections improperly as this can damage the backplane.

- Never supply a control voltage to X03.2 when the S1 switch is closed (S1.x = ON).
- Only operate multiple adjacent backplanes using a common control voltage or a common contact to avoid equalizing currents.

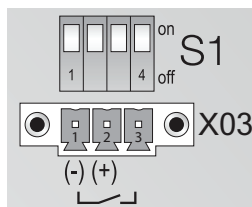

S1 Function Switch Positions (1719-A8)

S1.1	S1.2	S1.3	S1.4	Effect
ON	ON	ON	ON	Deactivation of the I/O modules is disabled.
OFF	OFF	OFF	OFF	Deactivation of the I/O modules equipped with a shutdown input is controlled by a control voltage at X03.
ON	OFF	ON	ON	Deactivation of the I/O modules equipped with a shutdown input is controlled by a voltage-free contact at X03.

X03 Terminal Assignment (1719-A8)

Terminal	Description
X03.1	0V
X03.2	12V DC...24V DC galvanically isolated control voltage (SELV), see Connector X03 item 1 on the figure below. Control current = $n \times \text{voltage} / 5.6 \text{ K}\Omega$ (where n = number of I/O modules equipped with a shutdown input)
X03.1 to X03.3	For external, voltage-free contact, galvanically isolated from other contacts and potentials, see Connector X03 item 2 on the figure below. This separation also applies to other contacts from other backplanes, unless this involves interconnecting the base backplane and the extension backplane, see Connector X03 item 3 on the figure below. The status information for the external contact can be read in using the 1719-IBN8B I/O module.

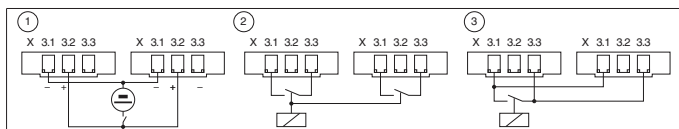

Connector X03

1 = Voltage control for 1 distributed I/O station.

2 = Control for 2 backplanes without external voltage

3 = Base and extension backplane, controlled in common (without external voltage)

X02 and X01 Terminal Assignment (1719-A8)

X02 Terminal Assignment	
X02.1	0V
X02.2	+24V DC
X03.3	Ground

X01 Terminal Assignment	
X01.1	0V
X01.2	+24V DC
X01.3	Ground

1719-A22, 1719-A24 Connections

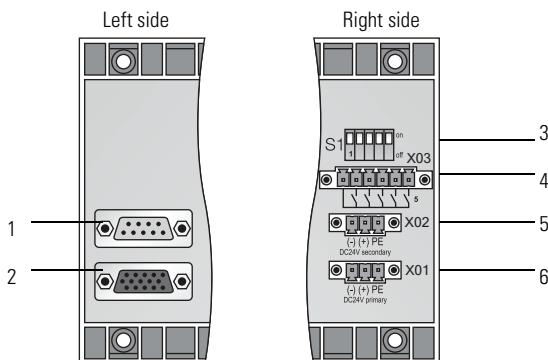

	Description		Description
1	X6: Service interface. Currently not used. Not present in 1719-A24 extension chassis.	3	S1: Function switch
		4	X03: Bus-independent deactivation of the I/O modules
2	X7: Extension connection for 1719-A24 extension chassis. Note: Online addition of an extension backplane while the system is in Run mode is not supported.	5	X02: 24V DC redundant power supply
		6	X01: 24V DC power supply

S1 Switch Positions and X03 Terminal Assignment (1719-A22, 1719-A24)

The S1 switch and X03 terminal control the bus-independent deactivation of the I/O modules.

The bus-independent deactivation of the I/O modules only works for I/O modules equipped with a shutdown input (1719-OB2, 1719-OB2L). I/O modules with and without a shutdown input can be installed on the same backplane; however, only the I/O modules that are equipped with a shutdown input are controlled by the bus-independent deactivation.

The backplanes are divided into five areas. Each area monitors different slots on the backplane. If I/O modules equipped with a shutdown input are installed on the backplane, the individual areas can be deactivated using an external switch.



ATTENTION: Damage to equipment

Do not handle connections improperly as this can damage the backplane.

- Never supply a control voltage to X03.2 ... X03.6. On backplanes 1719-A22 and 1719-A24, bus-independent deactivation of the I/O modules can be controlled by a voltage-free contact only.
- Only operate multiple adjacent backplanes using a common contact to avoid equalizing currents.

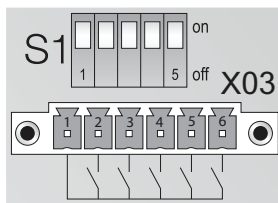

Backplane Areas

Area	1	2	3	4	5
1719-A22 slots	3...5	6...10	11...15	16...20	21...24
1719-A24 slots	25...29	30...34	35...39	40...44	45...48
S1 switch	S1.1	S1.2	S1.3	S1.4	S1.5
X03 contact	X03.2	X03.3	X03.4	X03.5	X03.6

S1 Switch Positions (1719-A22, 1719-A24)

S1.1...S1.5	Effect
S1.x = ON	Deactivation of the I/O modules in the associated area is disabled.
S1.x = OFF	Deactivation in the associated area is controlled by the corresponding X03 contact. If the X03 contact is open (X03.x = OFF), the I/O modules equipped with a shutdown input are deactivated for the corresponding area.

X02 and X01 Terminal Assignment (1719-A22, 1719-A24)

X02 Terminal Assignment	
X02.1	0V
X02.2	+24V DC
X03.3	Ground

X01 Terminal Assignment	
X01.1	0V
X01.2	+24V DC
X01.3	Ground

Inserting and Removing Modules

Fixed slots are reserved on the backplane for adapters and power supplies. Power supplies and adapters are equipped with mechanical coding pins on the underside of the housing to prevent these modules from being accidentally plugged into the slot of an I/O module.

Slots for I/O modules have equal status, meaning functions can be arranged in any sequence, as required.

Unused slots can be left empty or covered using the 1719-ARM placeholder module.

Removal and Insertion Under Power



WARNING: These modules are designed so you can **remove and insert them under power**. However, take special care when removing or inserting modules in an active process. I/O attached to any module being removed or inserted can change states due to its input/output signal changing conditions. If you insert or remove the module while backplane power is on, an electrical arc can occur. This could cause an explosion in hazardous location installations. Be sure that power is removed or the area is nonhazardous before proceeding.

Install I/O Modules

1. Arrange the I/O modules on the backplane from left to right.
2. Push the I/O module into a vacant slot on the backplane.
3. Make a note of the types of module used or other identification codes on the label carrier (available as accessory 1719-INLAY) above the I/O modules.

Remove I/O Modules

1. Remove the modules by positioning your thumb and index finger on the top and bottom of the module and pulling.

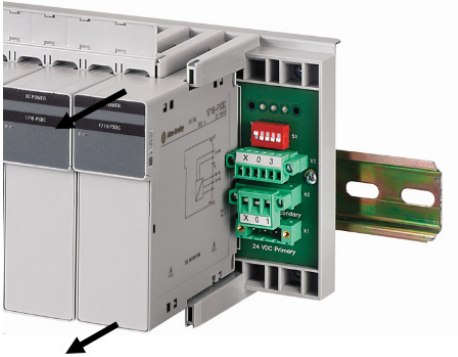

2. If necessary, adjust the information on the label carrier above the I/O modules.

Field Wiring



WARNING: Risk of explosion

Do not operate relay circuits without free-wheeling diodes as this can damage the relay contacts and cause sparks, which can cause explosive mixtures to ignite.

Fit free-wheeling diodes in relay circuits containing inductive loads.



WARNING: Risk of explosion

Measuring instruments that do not meet the requirements for use in hazardous areas can cause explosive mixtures to ignite.

Only use accessories and devices that are approved for use in the respective environment.

**ATTENTION:** Loss of intrinsic safety

If you operate circuits with Ex i type protection with non-intrinsically safe circuits, you can no longer use them as circuits with Ex i type protection.

Use only Ex i-certified measuring instruments in conjunction with Ex i-certified I/O modules.

Field connections can be made to the I/O modules using screw terminals or spring terminals. Use the terminal blocks from the range of accessories. For more information, refer to Accessories in Chapter 2 of the 1719 Ex I/O User Manual, publication number [1719-UM001](#).

Screw terminals or spring terminals are ideal for future expansion or for replacement of individual field connections, since the plug can remain in the front socket of the I/O module during wiring. These terminals offer a test plug socket for measuring individual current circuits.

The following connection data applies in conjunction with the terminal blocks listed here: 1719-TB6, 1719-TB6S, 1719-TB8, 1719-TB8S, 1719-TB8Sx2, 1719-TB8x2.

Connection data for screw terminals and spring terminals

Rigid conductor cross-section	0.14 mm ² ...1.5 mm ²
Flexible conductor cross-section	0.14 mm ² ...1.5 mm ²
Flexible conductor cross-section with wire end ferrule with no plastic sleeve	0.25 mm ² ...1.5 mm ²
Flexible conductor cross-section with wire end ferrule with plastic sleeve	0.25 mm ² ...0.5 mm ²

Installing Field Wiring

**WARNING:** Risk of explosion

Improperly wiring front connections can result in dangerous mistakes being made and cause explosive mixtures to ignite.

1. The I/O modules are wired differently depending on the model and function. Wire the terminal blocks to the field devices in accordance with the information in the technical data sheets for the I/O modules used.

2. Pay attention to the conductor cross-sections. We recommend that you do not exceed a conductor cross-section of 0.75 mm^2 .
3. Make sure that conductors are insulated all the way up to the terminal.
4. If you use multistranded conductors, make sure that they are equipped with wire end ferrules. We recommend using wire end ferrules approved according to the DIN 46228-4 directive.
5. Only use blue terminal blocks for intrinsically safe circuits.
6. Plug the terminals into the front sockets of the corresponding I/O modules and tighten the terminals using the side screws.
7. Connect unused cables to terminals or ensure that unused cables are fixed securely and insulated.

Coding

You can code the front sockets of the I/O modules and terminals so that the terminals and the associated field devices can be assigned to exactly one front socket.

Use the 1719-CP coding pins for the following terminal blocks: 1719-TB6S, 1719-TB8, 1719-TB8S, 1719-TB8Sx2, 1719-TB8x2.

Coding Connections



ATTENTION: Danger of incorrect connections

If the coding is not unique, terminals can be accidentally swapped.

Establish a unique coding so that every terminal fits exactly one front socket.

1. To code the front socket of an I/O module, insert one or more coding pins into the corresponding grooves on the front socket.
2. In order to code the terminal to match the front socket, cut off the plastic lugs from the terminal from those points where coding pins are located in the front socket.

Note that the coding in example 1 and example 2 is not unique. The terminal from example 1 could be accidentally connected to the front socket in example 2. In contrast, the coding in example 1 and example 3 is unique.

	Example 1	Example 2	Example 3
Terminal			
Front socket			

Line Fault Detection

Most I/O modules have a line fault detection function that can recognize a lead breakage or a short circuit.

If digital I/O modules are used, for example with a mechanical contact, an additional resistor circuit must be installed to ensure that the line fault detection function can work correctly. Using the additional resistor circuit, the electronics can distinguish between a closed switch and a short circuit.

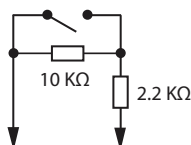

- 1719-IJ
If you are using direction detection, connect this input to a resistor circuit. The rotation direction input is ignored for devices without rotation direction detection.
- 1719-IBN8B
24-V and 5-V inputs can only be used when line fault detection is disabled.

The line fault detection function of the analog I/O modules is based on a current measurement. An additional resistor circuit is not required.

Line fault detection can be enabled or disabled by checking or clearing the **Enable Diagnostics** checkbox in the Add-on Profile respectively. Status will only be shown on the module LED.

For more information, refer to the Add-on Profile help topic for the module.

Cold Junctions in Thermocouples

The 1719-IT4B I/O module is equipped with an internal cold junction. However, it can be used with an external cold junction. Using the Add-on Profile, you can set the cold junction compensation mode to either Local (internal) or Remote (external).

For more information, refer to the Add-on Profile help topic for the 1719-IT4B module.

Wire Resistance in Resistance Thermometers

If you operate the 1719-IR4B I/O module in a 2-wire configuration, the wire resistance amounts to that of a resistor connected in series to the sensor and affects the measurement result. In order to avoid measurement errors, the wire resistance must be measured and compensated for in this configuration. Two options are available here:

Pt100 Short Circuit

1. Short circuit the Pt100 sensor.
2. Monitor the tag for the I/O module and make a note of the measured value.
3. In the Add-On Profile, using the Ch0x dialog, set the measuring input of the I/O module to 2-wire measurement with a Pt100 sensor.
4. Enter the measured resistance in the **Wire Resistance** field. The maximum permissible wire resistance is 50 Ω .

For more information, refer to the Add-on Profile help topic for the 1719-IR4B module.

Use a Calibrating Resistor

1. Use a calibrating terminal with an integrated calibrating resistor in the sensor supply line.
2. In the Add-On Profile, using the Ch0x dialog, set the measuring input of the I/O module to 2-wire measurement with a Pt100 sensor.

3. In the Add-On Profile, set the wire resistance to 20 Ω .
4. Replace the Pt100 sensor at the measuring point with a 100- Ω measurement resistor.
5. To measure the resistance, monitor the tag for the I/O module.
6. Set the displayed value to 0 C using the calibration potentiometer.
7. Then reconnect the Pt100 sensor.

For more information, refer to the Add-on Profile help topic for the 1719-IR4B module.

EtherNet/IP Connection



WARNING: Risk of explosion

Observe the wiring specifications set out in IEC 60079-14 or NEC 500-510 for wiring in Zone 2 or Division 2. Only connect or disconnect EtherNet/IP and power cables when the area is safe.



WARNING: Risk of explosion

Accessories that do not meet the requirements for use in hazardous areas can cause explosive mixtures to ignite.

Only use accessories and devices that are approved for use in the respective environment.

Cable Lengths

The following table relates to standard applications.

Bus system	Transfer rate	Max. cable length
EtherNet/IP	10/100 Mbps	100 m

Network switches or fiber optic cables can be used to extend the cable length.

Potential Equalization and Shielding

IMPORTANT The following sections cannot provide the reader with a complete picture of all requirements in terms of grounding, shielding, and lightning protection. More information on this topic can be found in the technical literature and the applicable standards.

Interference

Electromagnetic fields can interfere with the communication path.

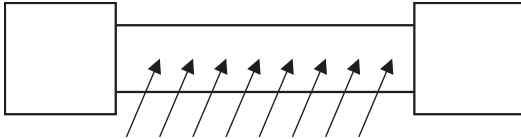

Interfering signals caused by induction in parallel conductors

Twisted-pair cables significantly reduce the influence of these interference fields, particularly when compared to cables with parallel strands. The direction of the recorded interference field in a twisted-pair cable reverses over short intervals. This means that the induced interference is practically canceled out, while in parallel strands the interference is active across the entire area.

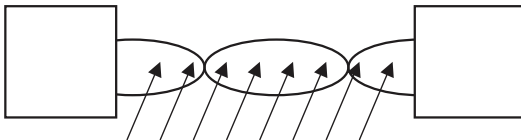

Reduced admission of interfering signals in twisted-pair cable

Shielding keeps interfering signals away from the communication path.

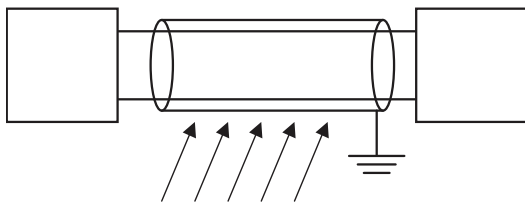

Shielding prevents the entry of interference fields

EMC filters are used in many devices to divert any interference to ground. For the sake of symmetry, all lines are provided with suitable capacitance. Capacitively coupled high frequency interference is effectively canceled out by the symmetrical layout.

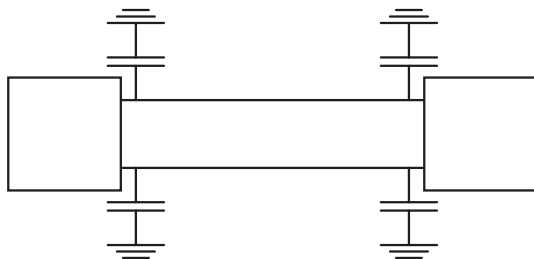

EMC filters in signal paths

The same applies to galvanically isolated signals. However, unexpected results may arise in networks created by multichannel systems without isolation. This is because the filter

capacitors may even run in parallel, depending on the setup. Isolate the channels to eliminate any interference.

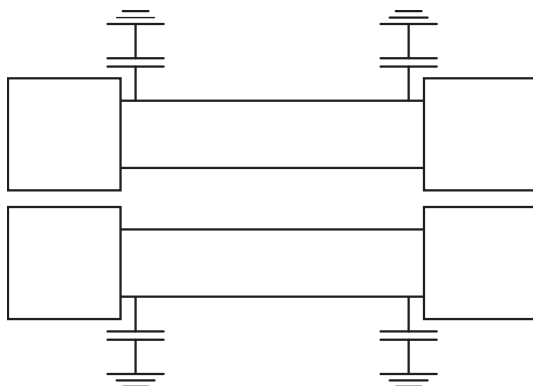

EMC filters in a network (simplified diagram)

Wiring



WARNING: Risk of explosion

Observe the specifications for installation as set out in IEC/EN 60079-14. For example, potential equalization ensures that the maximum resistance between different system components is 1Ω . This is the basis for calculating the required cable cross-section, depending on the distance between the system components.

Lay the signal leads such that they are separate from the power cables. Please note that AC voltages and current spikes can induce stray voltages in neighboring lines. As such, shielded, female single-ended cordsets should be used for EMC-tested devices.

Grounding rails can be laid separately from the shielding (see the IEC/EN 60079-14 directive). The shielding is then grounded at one point.

Field Wiring

Depending on the application, the shielding of the wiring must be grounded at one point or at both ends. If possible, avoid grounding at both ends to prevent ground loops and ensure the shielding is not used as a return line.

Sound results can be obtained with grounding at one end of the cable if the cable is laid on a grounded metal cable support. The metal frame in the immediate vicinity of the conductor ensures that only small areas are exposed to the field, so that interference is largely reduced.

Digital inputs are normally controlled by NAMUR proximity switches with a low-impedance signal. In this case, interfering signals have a far lower impact than in circuits containing open switches that do not have an additional resistor circuit. For this reason, do not connect digital inputs to exposed wiring.

The analog signals of resistive sensors or thermocouples are particularly susceptible to interference. Measuring transmitters have built-in filters to reduce this interference. The filters can be switched on if fluctuations in the measuring signal cannot be reduced sufficiently by other means.

Eliminating Interference

The following measures can improve performance.

1. Fit line filters in power supply lines.
2. Fit surge protection filters in signal leads.
3. Change to galvanically isolated circuits

Additional Resources

Resource	Description
1719 Ex I/O User Manual, publication 1719-UM001	Provides information on using the 1719 Ex I/O modules, backplanes, and accessories.
1719 Ex I/O Technical Data, publication 1719-TD001	Provides specifications, wiring diagrams and module block diagrams for 1719 Ex I/O.
Industrial Automation Wiring and Grounding Guidelines, publication 1770-4.1	Provides general guidelines for installing a Rockwell Automation industrial system.
Product Certifications website, http://www.rockwellautomation.com/rockwellautomation/certification/overview.page	Provides declarations of conformity, certificates, and other certification details.

You can view or download publications at <http://literature.rockwellautomation.com/>. For Release Notes and other publications specific to your module, search the catalog number of the module.

To order paper copies of technical documentation, contact your local Allen-Bradley distributor or Rockwell Automation sales representative.

Notes:

Rockwell Automation Support

Rockwell Automation provides technical information on the Web to assist you in using its products. At <http://www.rockwellautomation.com/support/>, you can find technical manuals, a knowledge base of FAQs, technical and application notes, sample code and links to software service packs, and a MySupport feature that you can customize to make the best use of these tools.

For an additional level of technical phone support for installation, configuration and troubleshooting, we offer TechConnect support programs. For more information, contact your local distributor or Rockwell Automation representative, or visit <http://www.rockwellautomation.com/support/>.

Installation Assistance

If you experience a problem within the first 24 hours of installation, please review the information that's contained in this manual. You can also contact a special Customer Support number for initial help in getting your product up and running.

United States or Canada	1.440.646.3434
Outside United States or Canada	Use the Worldwide Locator at http://www.rockwellautomation.com/support/americas/phone_en.html , or contact your local Rockwell Automation representative.

New Product Satisfaction Return

Rockwell Automation tests all of its products to ensure that they are fully operational when shipped from the manufacturing facility. However, if your product is not functioning and needs to be returned, follow these procedures.

United States	Contact your distributor. You must provide a Customer Support case number (call the phone number above to obtain one) to your distributor to complete the return process.
Outside United States	Please contact your local Rockwell Automation representative for the return procedure.

Documentation Feedback

Your comments will help us serve your documentation needs better. If you have any suggestions on how to improve this document, complete this form, publication [RA-DU002](#), available at <http://www.rockwellautomation.com/literature/>.

Allan-Bradley, Rockwell Automation, RSLogix, RSLinx, and Studio 5000 are trademarks of Rockwell Automation, Inc.

Trademarks not belonging to Rockwell Automation are property of their respective companies.

Rockwell Automation maintains current product environmental information on its website at <http://www.rockwellautomation.com/rockwellautomation/about-us/sustainability/ethics/product-environmental-compliance.page>.

Rockwell Otomasyon Ticaret A.Ş., Kar Plaza İş Merkezi E Blok Kat:6 34752 İçerenköy, İstanbul, Tel: +90 (216) 5698400

www.rockwellautomation.com

Power, Control and Information Solutions Headquarters

Americas: Rockwell Automation, 1201 South Second Street, Milwaukee, WI 53204-2496 USA, Tel: (1) 414.382.2000, Fax: (1) 414.382.4444
Europe/Middle East/Africa: Rockwell Automation, Vorstlaan/Boulevard du Souverain 36, 1170 Brussels, Belgium, Tel: (32) 2 663 0600, Fax: (32) 2 663 0640
Asia Pacific: Rockwell Automation, Level 14, Core F, Cyberport 3, 100 Cyberport Road, Hong Kong, Tel: (852) 2887 4788, Fax: (852) 2508 1846

Publication 1719-IN001A-EN-E - October 2016